

ST7001

Smartpilot

Controller

Operating Guide

Document number: 81225-1
Date: July 2003

Autohelm, HSB (High Speed Bus), SailPilot, SeaTalk and SportPilot are registered trademarks of Raymarine Ltd.

Raymarine, AST (Advanced Steering Technology), AutoAdapt, AutoLearn, AutoRelease, AutoSeastate, AutoTack, AutoTrim, FastTrim, GyroPlus, RayGyro, RayPilot and WindTrim are trademarks of Raymarine Ltd.

Handbook contents © Raymarine Ltd. 2003.

Important Information

About the documentation provided

Welcome to Raymarine SmartPilot. The autopilot system that will steer your boat to a heading automatically, accurately, reliably and comfortably.

SmartPilot documentation is arranged so that you can install, commission and quickly use your SmartPilot, keeping to hand only the information necessary.

- **Installation Sheets** - One per element of the system, these easy to understand sheets guide you through the installation process. These can be discarded once the installation is complete.
- **SmartPilot Commissioning Guide** - Describes how to connect, commission and configure the system.
- **Quick Start Guide** - Once commissioned, use your Smart Pilot right away with this handy guide to the main operations.
- **Operating Guide** - This handbook. Contains a detailed description of the SmartPilot's features and functions.

Warranty

To register your new Raymarine product, please take a few minutes to fill out the warranty card. It is important that you complete the owner information and return the card to us to receive full warranty benefits.

Safety notices



WARNING: Calibration

We supply this product calibrated to default settings that should provide initial stable performance for most boats. To ensure optimum performance on your boat, you must complete the procedures in *SmartPilot Commissioning Guide* before use.



WARNING: Navigation aid

Although we have designed this product to be accurate and reliable, many factors can affect its performance. As a result, it should only be used as an aid to navigation and should never replace common sense and navigational judgement. Always maintain a permanent watch so you can respond to situations as they develop.

Your Raymarine SmartPilot will add a new dimension to your boating enjoyment. However, it is the skipper's responsibility to ensure the safety of the boat at all times by following these basic rules:

- Ensure that someone is present at the helm AT ALL TIMES, to take manual control in an emergency.
- Make sure that all members of crew know how to disengage the autopilot.
- Regularly check for other boats and any obstacles to navigation – no matter how clear the sea appears, a dangerous situation can develop rapidly.
- Maintain an accurate record of the boat's position by using either a navigation aid or visual bearings.
- Maintain a continuous plot of your boat's position on a current chart. Ensure that the locked autopilot heading will steer the boat clear of all obstacles. Make proper allowance for tidal set – the autopilot cannot.
- Even when your autopilot is locked onto the desired track using a navigation aid, always maintain a log and make regular positional plots. Navigation signals can produce significant errors under some circumstances and the autopilot will not be able to detect these errors.

EMC Conformance

All Raymarine equipment and accessories are designed to the best industry standards for use in the recreational marine environment. Their design and manufacture conforms to the appropriate Electromagnetic Compatibility (EMC) standards, but correct installation is required to ensure that performance is not compromised.

Handbook information

To the best of our knowledge, the information in this handbook was correct when it went to press. However, Raymarine cannot accept liability for any inaccuracies or omissions it may contain. In addition, our policy of continuous product improvement may change specifications without notice. As a result, Raymarine cannot accept liability for any differences between the product and the handbook.

Contents

Important Information	iii
About the documentation provided	iii
Warranty	iii
Safety notices	iii
EMC Conformance	iv
Handbook information	iv
Chapter 1: SmartPilot Operation	1
1.1 Introduction	1
1.2 Using the control unit	3
Start-up mode	3
Keypad functions	3
What does the display tell me?	4
1.3 Using the SmartPilot to steer your boat	5
How do I automatically steer to a heading?	5
How do I return to hand steering?	5
How do I change course in Auto mode?	6
Can I dodge an obstacle and then resume course?	6
1.4 How do I adjust the performance of my SmartPilot?	7
Off Course warning	9
1.5 Using the SmartPilot with sail boats	10
1.6 Can I adjust the display lighting and contrast?	11
How do I adjust the lights?	11
How do I adjust the contrast?	12
Chapter 2: Advanced Operation	13
2.1 How do I follow a route set on a Chartplotter?	13
How do I activate Track mode?	13
How do I leave Track mode?	14
What is Cross track error?	14
Tidal stream compensation	15
How do I dodge an obstacle in Track mode?	15
What happens when I arrive at a waypoint?	16
What happens when I get to the end of the route?	17
Safety in Track mode	18
2.2 Using Wind Vane mode – sail boats	18
What is Wind Vane mode?	18
How do I select Wind Vane mode?	19
How do I leave Wind Vane mode?	19
How do I adjust the locked wind angle	19
How do I dodge an obstacle in Wind Vane mode?	20

What is a Wind Shift warning?	20
How do I use AutoTack in Wind Vane mode?	20
Operating hints for Wind Vane mode	21
2.3 How do I display boat data?	21
Can I display Waypoint names?	22
Warning messages	23
2.4 User Calibration Options	23
How do I access User Calibration settings?	23
User Calibration pages	24
Chapter 3: Fault Finding & Maintenance	27
3.1 Fault finding	27
SmartPilot alarm messages	28
3.2 General maintenance	30
Routine checks	30
Cleaning the display	30
EMC advice	30
Product support	31
Specifications	33
ST7001 control unit	33
SmartPilot computer functions	33
Glossary	34
Index	37

Chapter 1: SmartPilot Operation

1.1 Introduction

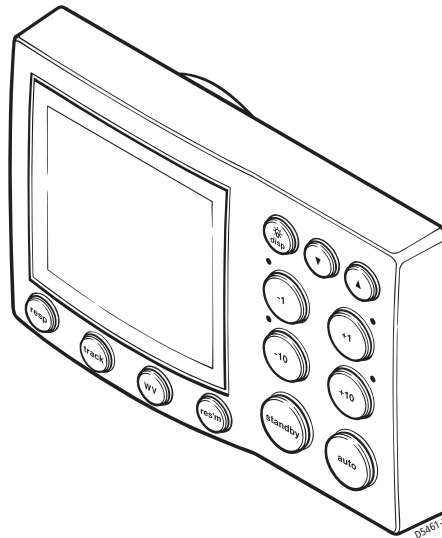

The SmartPilot controller is a SeaTalk® compatible autopilot control unit. It is designed as the main controller for the SmartPilot system.

The SmartPilot controller operates in the following modes:

- **Standby:** SmartPilot off. You have manual control of the boat
- **Auto:** The SmartPilot steers the boat to maintain a locked heading
- **Track:** The SmartPilot steers the boat to maintain a track between two waypoints created on a navigation aid
- **Wind Vane:** The SmartPilot steers the boat to maintain a course relative to a true or apparent wind angle

The SmartPilot controller also provides:

- automatic tack (AutoTack) in Auto and Wind Vane modes
- waypoint advance feature in Track mode

SmartPilot Functions

The functions provided with your SmartPilot system depend on whether the SmartPilot computer contains an internal GyroPlus yaw sensor

S1G, S2G and S3G systems (with GyroPlus)	Non-G systems (without GyroPlus)
Internal GyroPlus yaw sensor provides enhanced course keeping using AST (Advanced Steering Technology)	Full basic functionality: uses Raymarine steering algorithm without AST
Steering to true and apparent wind in Wind Vane mode	Steering to true and apparent wind in Wind Vane mode
Equipped with AutoLearn, Raymarine's self-learning calibration system	

Extended systems

You can connect the SmartPilot controller to other Raymarine SeaTalk equipment so it can send and receive SeaTalk data:

- it can use waypoint information from a SeaTalk navigation instrument to provide track control
- it can use boat speed from a SeaTalk speed instrument to optimize track-keeping performance
- it can use wind information from a SeaTalk wind instrument for Wind Vane steering

You can also use the SmartPilot with any navigator or wind instrument that transmits National Marine Electronics Association (NMEA) 0183 data.

The SmartPilot control unit can display SeaTalk and NMEA instrument data in a user-defined selection of data pages.

For further information on other connections to your system see *SmartPilot Commissioning Guide*

1.2 Using the control unit

Start-up mode

The SmartPilot always powers up in Standby mode with the display showing the boat's current compass heading.

Note: You can press **standby** at any time to return to manual steering.

Keypad functions

The SmartPilot is controlled using simple push-button operations, all of which are confirmed with a short beep. In addition to the main single-key functions, there are several dual key operations.

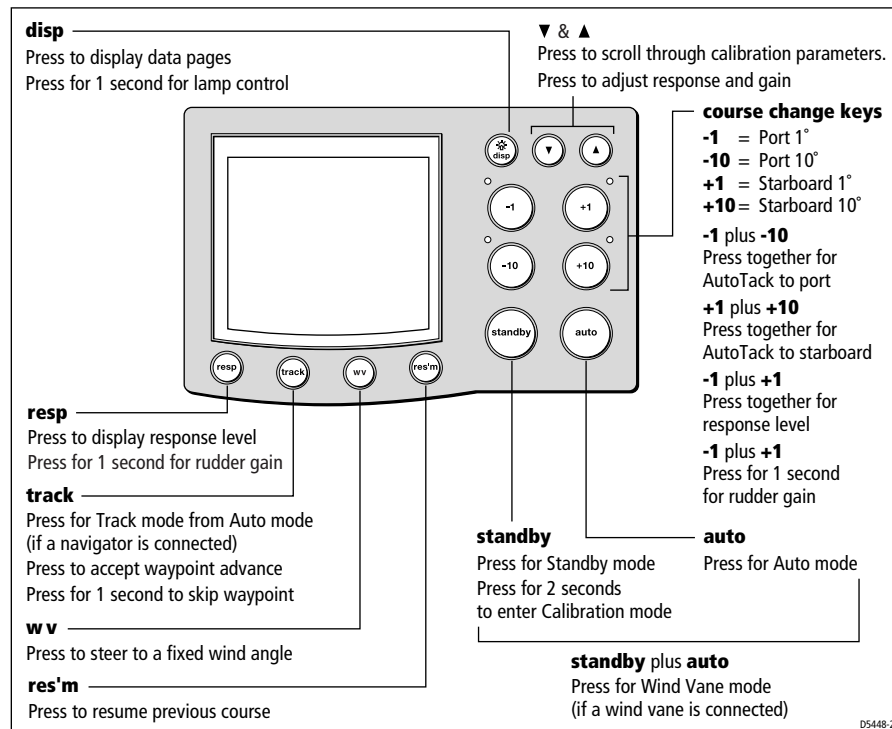

What does the display tell me?

The SmartPilot display screen provides the following information:

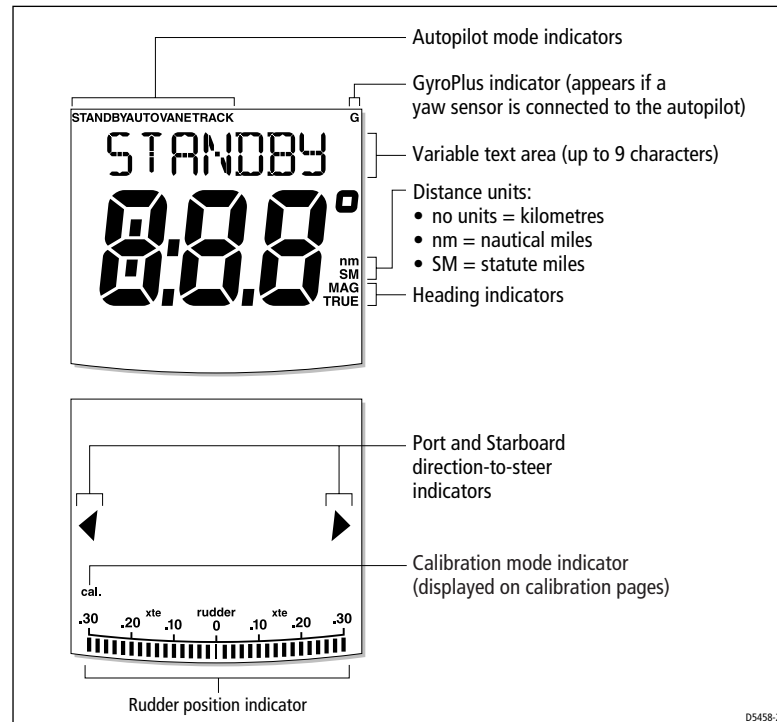

The bar graph at the bottom of the screen indicates the current position of the rudder, as measured by the rudder position sensor.

1.3 Using the SmartPilot to steer your boat

How do I automatically steer to a heading?

1. Steady the boat on the required heading.
2. Press **auto**

The SmartPilot is now in **AUTO** mode and will steer to the chosen heading, shown on the display. This mode is often known as “point-and-shoot”.

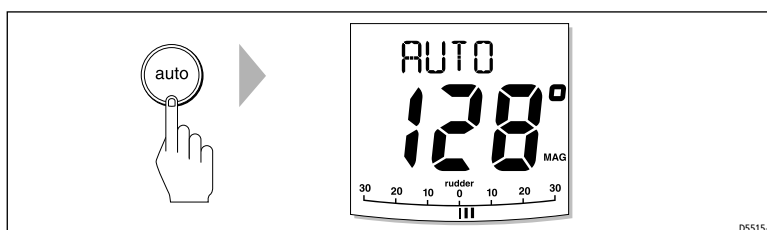

CAUTION:

Automatic course control makes it easier to sail a boat, but it is **NOT** a substitute for good seamanship. **ALWAYS** maintain a permanent watch by the helm.

How do I return to hand steering?

Press **standby** to disengage the SmartPilot:

- in **STANDBY** mode, you have manual control of the boat and the display shows the boat's current compass heading.

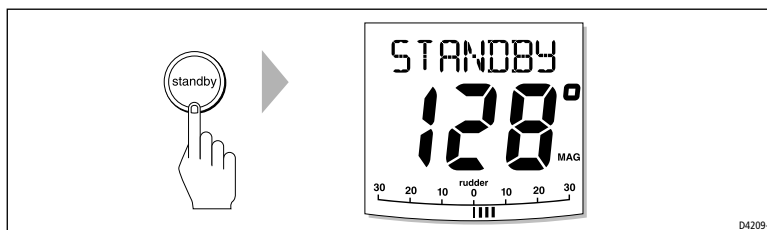

How do I change course in Auto mode?

In Auto mode, use the **-1** and **-10** (port) and **+1** and **+10** (starboard) keys to change the locked heading in steps of 1° or 10°. For example: press **-10** three times for a 30° course change to port.

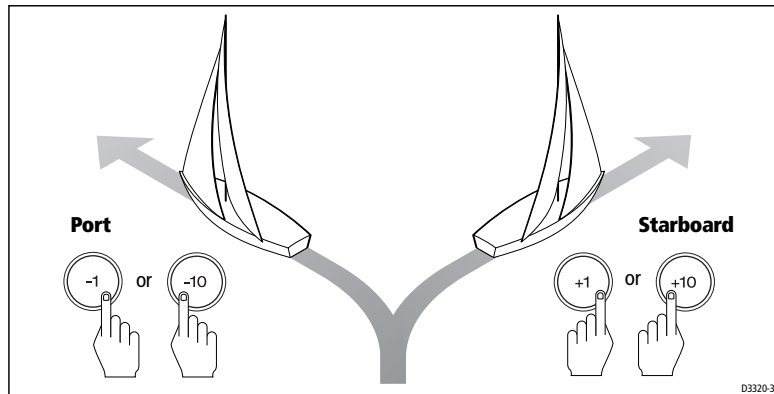

Can I dodge an obstacle and then resume course?

To avoid an obstacle when your boat is under autopilot control, you can dodge the obstacle and then resume your previous course.

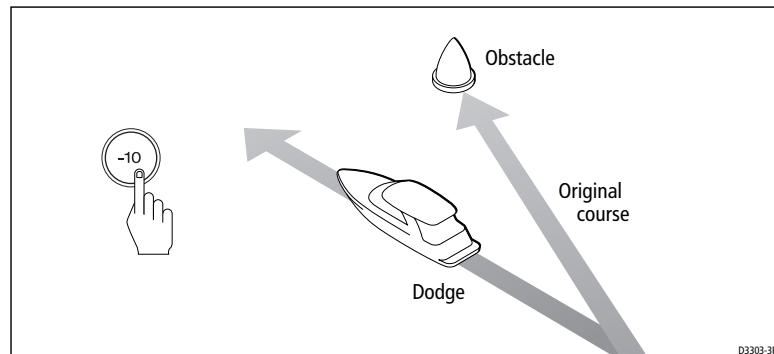

1. Select a course change in the appropriate direction. For example, press **-10** three times for a 30°dodge to port.
2. When safely clear of the obstacle, reverse the previous course change (for example, press **+10** three times).

1.4 How do I adjust the performance of my SmartPilot?

The principal method of adjusting the performance of SmartPilot systems is by changing the response level. This is the only user adjustment you should need to make to your SmartPilot on a regular basis.

The response level controls the relationship between the SmartPilot's course keeping accuracy and the amount of helm/drive activity. When you turn on your SmartPilot it will always be at the default level. (This level can be adjusted in User Calibration *see page 23*)

When you require extra tight course keeping (e.g. for pilotage in confined and sheltered waters), increase the setting. If you want to minimize drive activity and conserve battery power, decrease the setting.

You can make temporary adjustments to the response level when using your SmartPilot on a day-to-day basis. By doing this you can match performance to conditions as they occur.

Note: *You will lose these temporary changes to response level whenever the system is powered off. You can make **permanent** adjustments in User Calibration (See page 23). This determines the default power-up response level.*

Adjusting performance – S1G, S2G and S3G systems

S1G, S2G and S3G systems have 9 levels of response:

- **level 9 to 7** give the tightest course keeping and greatest rudder activity (and power consumption). This can lead to a rough passage in open waters as the SmartPilot may 'fight' the sea.
- **levels 6 to 4** should give good course keeping with crisp, well controlled turns under normal operating conditions
- **level 3 to 1** minimizes the amount of pilot activity. This conserves power, but may compromise short-term course-keeping accuracy

With these points in mind, you should use the following procedure to make temporary adjustments to the response level when required:

1. Display the RESPONSE screen by pressing either the **resp** key or the **-1** and **+1** keys together momentarily.

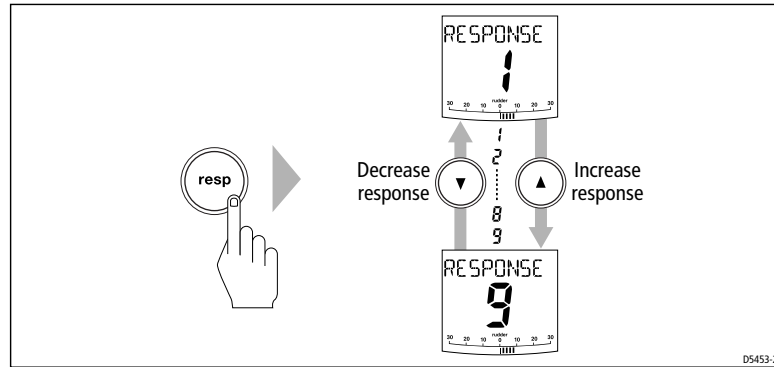

Note: The RESPONSE screen is set as a default data page (see SmartPilot Commissioning Guide) so you can also access it by pressing **disp** and then scrolling through the data pages.

2. Press **-1** or **+1** or the **up** or **down** arrow keys to change the response level.
3. Press **disp** or wait for 5 seconds to return to the previous display.

Adjusting performance – Non-G systems

Non-G SmartPilot systems have three different response levels:

- **Response Level 1: AutoSeastate on (Automatic deadband)**
The SmartPilot will gradually ignore repetitive boat movements and only react to true variations in course. This provides the best compromise between power consumption and course keeping accuracy
- **Response Level 2: AutoSeastate off (Minimum deadband)**
This setting provides tighter course keeping but will lead to increased power consumption and drive unit activity
- **Response Level 3: AutoSeastate off + yaw damping**
This setting provides the tightest possible course keeping by introducing counter rudder yaw damping. You can adjust the counter rudder setting in Dealer Calibration (see SmartPilot Commissioning Guide)

To make a **temporary** change to the response setting:

1. Display the RESPONSE screen by pressing either the **resp** key or the **-1** and **+1** keys together
2. Press **-1** or **+1** or the up arrow or down arrow keys to change the response between levels 1 to 3.
3. Press **disp** or wait for 5 seconds to return to the previous display.

Note: You will lose these temporary changes to response level whenever the system is powered off. You can make **permanent** adjustments in User Calibration (see page 23).

Off Course warning

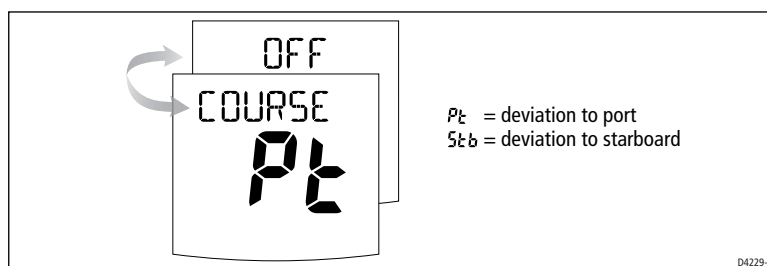

The SmartPilot warns you when you have been off course from the locked heading for longer than 20 seconds. It shows whether the deviation is to port or starboard.

Note: The default off course angle is set at 20°. You can adjust this angle in Dealer Calibration (see SmartPilot Commissioning Guide).

1. To cancel the off course warning, press **standby** to return to manual steering.
2. Check whether your boat is carrying too much sail, or whether the sails are badly balanced. You can usually significantly improve course keeping by improving the sail balance.

Note: The SmartPilot also clears the warning if the heading recovers or if you change course.

1.5 Using the SmartPilot with sail boats

Using the SmartPilot to automatically tack (AutoTack)

The SmartPilot has a built in automatic tack facility (AutoTack) that turns the boat through 100° in the required direction. If you have set the vessel type to SAIL BOAT, you can adjust the default AutoTack angle in User Calibration (see page 23).

- to AutoTack to port: press the **-1** and **-10** keys together
- to AutoTack to starboard: press the **+1** and **+10** keys together

CAUTION:

When making major course changes, the trim on the boat may change substantially. Due to this, the SmartPilot may take some time to settle accurately onto the new course.

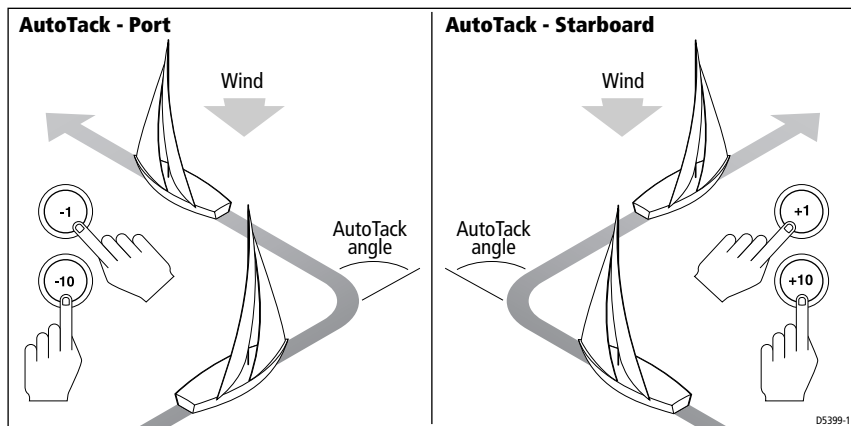

How do I prevent accidental gybes?

Note: For the gybe inhibit feature to work, the SmartPilot needs suitable wind information (see page 25).

The gybe inhibit feature stops the boat from performing an AutoTack away from the wind – this will prevent accidental gybes. This feature can be disabled if required.

With gybe inhibit on:

- you will be able to perform an AutoTack into the wind
- to prevent accidental gybes, the autopilot will prevent the boat from performing an AutoTack away from the wind

With gybe inhibit off:

- you can perform an AutoTack into or away from the wind.

Note: *Gybe inhibit is switched on as a default but can be disabled in User Calibration (see page 23).*

Gusty conditions

In gusty conditions, the course may tend to wander slightly, particularly if the sails are badly balanced. If you take the following precautions, the SmartPilot will be able to maintain competent control even in gale force conditions:

- You can improve course keeping by improving the sail balance:
 - do not allow the boat to heel over excessively
 - ease the mainsheet traveller to leeward to reduce heeling and weather helm
 - if necessary, reef the mainsail a little early
- In very strong winds and large seas, you should avoid sailing with the wind dead astern:
 - ideally, bring the wind at least 30° away from a dead run
 - in severe conditions, you may also need to remove the mainsail and sail under headsail only

1.6 Can I adjust the display lighting and contrast?

How do I adjust the lights?

You can adjust the display and keypad lighting by:

1. Pressing **disp** for 1 second from any mode to access the LAMP screen and turn on the lights.
2. Press the **disp** key to cycle through the possible illumination settings: LAMP 3 (the brightest setting), LAMP 2, LAMP 1, OFF, LAMP 1, LAMP 2, LAMP 3 and so on:
 - as you change the setting, the illumination on any other SeaTalk instruments or control units will also change

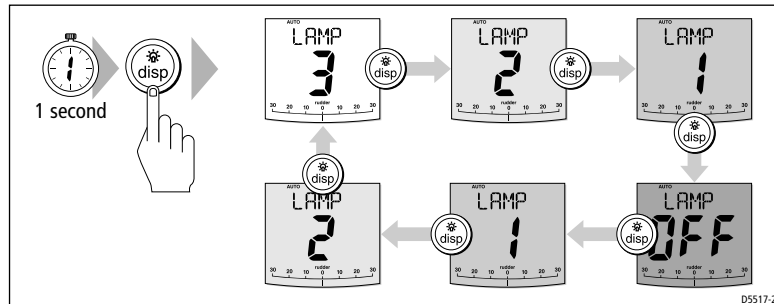

3. The display automatically returns to the previous mode if you do not press a key for 10 seconds:
- if you press another mode key within 10 seconds you will select the mode assigned to that key (for example: **auto** selects Auto mode, **standby** selects Standby mode)

Notes: (1) You can also adjust the lighting level from any other SeaTalk instrument or control unit.

(2) When you switch off the unit you lose any changes you have made to the lighting level.

How do I adjust the contrast?

To set the contrast level for the ST7001 display:

- With the autopilot in Standby mode, press the **disp** key for one second to access the LAMP screen.
- Press the **disp** key for one second again, to display the CONTRAST screen.
- Use the **up** and **down** arrow keys to set the required contrast level (from 1 to 15).
- The display automatically returns to the previous mode if you do not press a key for 10 seconds:

Note: if you press another mode key within 10 seconds you will select the mode assigned to that key (for example: **auto** selects Auto mode, **standby** selects Standby mode)

Chapter 2: Advanced Operation

2.1 How do I follow a route set on a Chartplotter?

By using TRACK mode, the SmartPilot can maintain a route between waypoints created on a navigation system. It makes any course changes necessary to keep your boat on course, automatically compensating for tidal streams and leeway.

Track mode is only available if you have connected the SmartPilot to a suitable navigation system providing SeaTalk or NMEA information. (See *SmartPilot Commissioning Guide for connection details*)

Your SmartPilot system can receive route information from:

- a SeaTalk navigation instrument or chartplotter
- a navigation system transmitting data in NMEA 0183 format.

How do I activate Track mode?

CAUTION:

When you enter Track mode, the SmartPilot will bring the boat onto the track in a controlled way. The closer the boat is to the correct heading and track, the quicker it will settle the boat onto the new course. To avoid an unexpected turn, approximately align the boat with the required track before entering Track mode.

Starting with the SmartPilot in AUTO mode and your chartplotter following a route.

1. Press **track** to enter Track mode.
2. Wait for the warning to sound.
The display will show the bearing to the next planned waypoint and the direction in which the boat will turn to reach this waypoint.
3. If it is safe for the boat to turn onto the new course, press the **track** key:
 - the SmartPilot will turn the boat onto the new course.
 - the display shows the heading required to achieve the required track

Note: *The closer the boat is to the correct heading and track when you press **track**, the quicker the SmartPilot will bring the boat onto the new course. If the boat is more than 0.3 nm from the track, the Large Cross Track Error warning will sound (see page 14).*

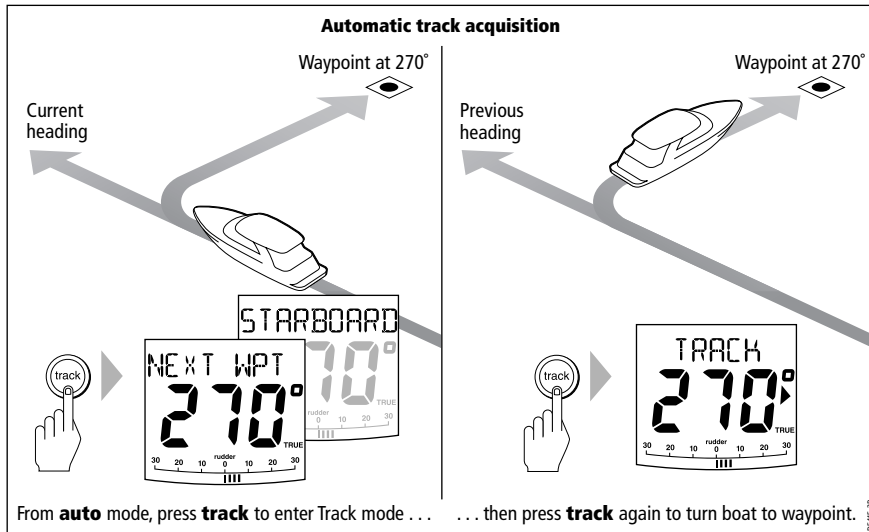

How do I leave Track mode?

You can leave Track mode at any time by:

- pressing **auto** to return to Auto mode
- pressing **standby** to steer manually in Standby mode

What is Cross track error?

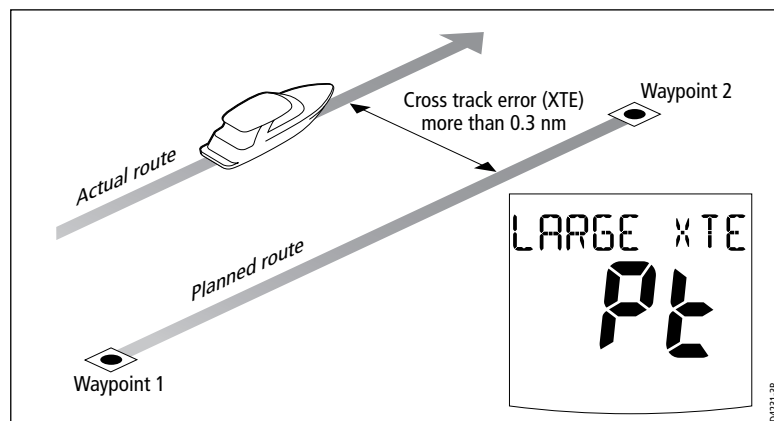

Cross track error (XTE) is the distance between the current position and a planned route. The SmartPilot receives the cross track error information

from the navigation equipment, and displays the XTE in nautical miles (nm), statute miles (SM) or kilometres (km).

If the cross track error is greater than 0.3 nm, the SmartPilot will sound the Large Cross Track Error warning and show whether you are to the port (Pt) or starboard (Stb) of the planned track.

Tidal stream compensation

Under most conditions, the SmartPilot will hold the selected track to within ± 0.05 nm (300 ft) or better. It takes account of the boat's speed when computing course changes to ensure optimum performance.

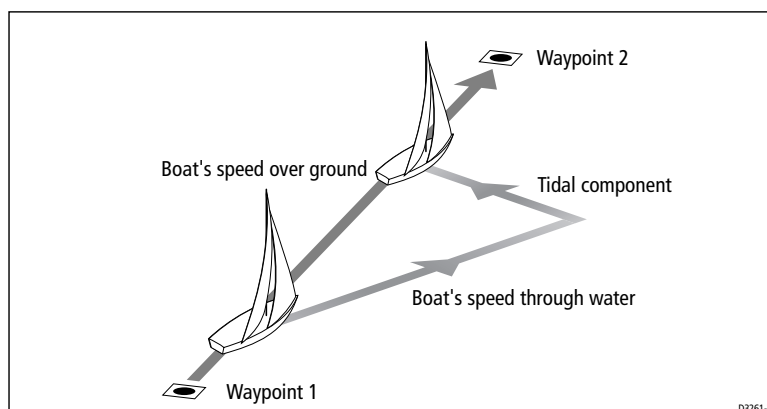

How do I dodge an obstacle in Track mode?

In Track mode you still have full control from the keypad. You can make a dodge maneuver by using the course change keys (**-1**, **+1**, **-10** or **+10**) to select the desired course change.

After you have avoided the hazard, you can cancel the dodge course change by making an equal course change in the opposite direction.

What happens when I arrive at a waypoint?

As the boat arrives at the target waypoint the chartplotter will select the next target waypoint and transmit this to the SmartPilot. It will then detect the new target waypoint name, sound a Waypoint Advance warning and display the Waypoint Advance (NEXT WPT) screen. This shows the new bearing to the next waypoint and the direction the boat will turn to acquire the new track.

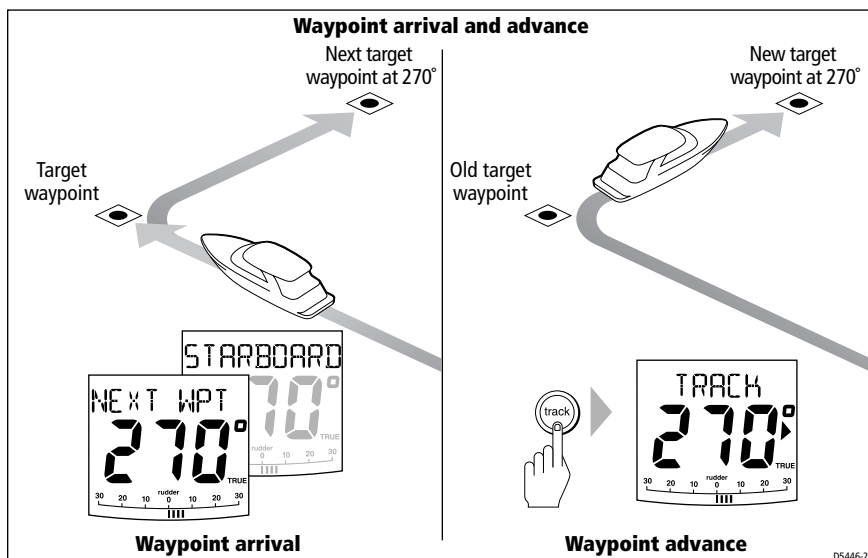

How do I get to the next waypoint in a route?

When the Waypoint Advance warning sounds, the SmartPilot suspends Track mode and maintains the current boat heading. To advance to the next waypoint:

1. Check that it is safe to turn onto the new track.
2. Press the **track** key. This will cancel the Waypoint Advance warning and turn the boat towards the next waypoint.

Note: If you do not press **track** to accept the Waypoint Advance, the SmartPilot will maintain the current heading and continue sounding the warning.

How do I skip a waypoint? (SeaTalk chartplotters)

If you want to advance to the next waypoint **before** you have arrived at the target waypoint, you can skip a waypoint by pressing **track** for 1 second. The display will then show the Waypoint Advance screen for the next waypoint.

Check it is safe to turn, then press **track** to turn the boat towards the next waypoint.



WARNING:

Skipping a waypoint will take you straight to the next waypoint. Check your navigation before making the turn.

What is the Waypoint Advance warning?

The SmartPilot activates the Waypoint Advance warning (NEXT WPT?) in Track mode whenever the target waypoint name changes. This occurs when:

- you select automatic acquisition by pressing **track** from Auto
- you request waypoint advance by pressing **track** for 1 second in Track mode (with SeaTalk navigators only)
- the boat arrives at the target and the navigator accepts the next waypoint
- you activate the Man Overboard (MOB) function (see *page 23*)

When the warning sounds, the SmartPilot continues on its current heading but displays:

- the bearing to the next waypoint
- the direction the boat will turn to take up that bearing

How do I respond to a Waypoint Advance warning?

To respond to a Waypoint Advance warning:

- check that it is safe to turn onto the new **track**, then press track to accept the waypoint advance
- alternatively, you can cancel the warning without accepting the waypoint advance by pressing:
 - **auto** to continue on the same heading, or
 - **standby** to return to manual control

What happens when I get to the end of the route?

The SmartPilot displays the ROUTE COMPLETED warning when you have reached the last waypoint on a route in Track mode.

- press **auto** to continue on the same heading
- or press **standby** to return to manual control

Safety in Track mode

CAUTION:

Track mode provides accurate track keeping even in complex navigational situations. However, it is still the skipper's responsibility to ensure the safety of their boat at all times through careful navigation and frequent position checks. Track mode assists precise navigation and removes the tasks of compensating for wind and tidal drift. However, you **MUST** still maintain an accurate log with regular plots.

2.2 Using Wind Vane mode – sail boats

Note: *You can only select Wind Vane mode if the SmartPilot is receiving suitable SeaTalk or NMEA wind direction information.*

What is Wind Vane mode?

When the SmartPilot is in Wind Vane mode it uses the fluxgate compass as the primary heading reference. As changes in the true or apparent wind angle occur, it adjusts the locked heading to maintain the original wind angle.

Wind information

To use Wind Vane mode, the SmartPilot must receive wind information from one of the following sources:

- SeaTalk wind instrument connected to the autopilot via SeaTalk
- NMEA wind instrument
- Raymarine pushpit wind vane connected via a SeaTalk interface

True and apparent wind

SmartPilots can maintain a course relative to either an apparent or true wind angle in Wind Vane mode

The default setting is apparent wind. If required, you can change this to true wind in User Calibration (see *page 25*).

WindTrim

In Wind Vane mode the SmartPilot uses WindTrim to eliminate the effects of turbulence and short term wind variations. This provides smooth and precise performance with minimal power consumption. You can adjust the wind response (WindTrim) level in User Calibration (see *page 25*) to control how quickly the SmartPilot responds to changes in the wind direction. Higher

wind trim settings will result in a pilot that is more responsive to wind changes.

How do I select Wind Vane mode?

You can select Wind Vane mode from either Standby or Auto mode:

1. Steady the boat onto the required wind angle.
2. Press **w v** to select Wind Vane mode and lock the current wind angle:
 - the display shows the locked heading (e.g. 128°) and the wind angle (e.g. WIND 145P indicates a wind angle of 145° to port)
 - if the SmartPilot does not enter Wind Vane mode, it is not receiving wind data - check the instrument and connections

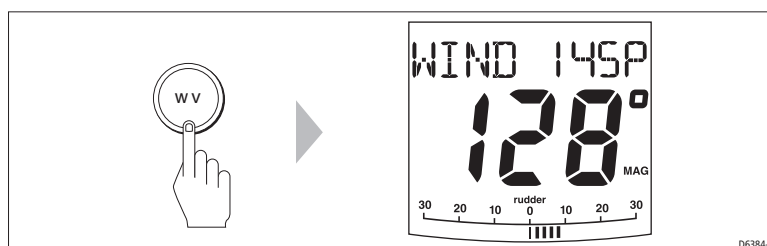

3. In Wind Vane mode, the SmartPilot will then adjust the boat's heading to maintain the locked wind angle.

How do I leave Wind Vane mode?

You can leave Wind Vane mode by:

- pressing **auto** to return to Auto mode
- pressing **standby** to return to manual control

How do I adjust the locked wind angle

You can adjust the locked wind angle by using the **-1**, **+1**, **-10** and **+10** keys to change course. For example, to bear away by 10° when the boat is on a starboard tack:

- press **-10** to turn the boat 10° to port – the locked wind angle and locked heading will both change by 10°
- the autopilot will then adjust the locked heading as required to maintain the new wind angle

Note: *Because turning the boat affects the relationship between the true and apparent wind angles, you should only use this method to make **minor** adjustments to the wind angle. For major changes, return to Standby mode, steer onto the new heading, then reselect Wind Vane mode.*

How do I dodge an obstacle in Wind Vane mode?

In Wind Vane mode you still have full control from the keypad. You can make a dodge maneuver by using the course change keys (**-1**, **+1**, **-10** or **+10**) to select the desired course change.

After you have avoided the hazard, you can cancel the dodge course change by making an equal course change in the opposite direction.

What is a Wind Shift warning?

If the autopilot detects a wind shift of more than 15° it will sound the wind shift warning and display the WIND SHIFT message:

- To cancel the warning, and retain the existing wind angle and new heading, press **standby** and **auto** together.
- Alternatively, to cancel the warning and return to the previous heading:
 - adjust the locked wind angle using the **-1**, **+1**, **-10** and **+10** keys.
 - press **standby** to return to hand steering, steer onto the required heading, and press **standby** and **auto** together to return to Wind Vane mode with the new wind angle

How do I use AutoTack in Wind Vane mode?

Note: *If you use the AutoTack function in Wind Vane mode, make sure the wind vane has been centered accurately.*

The SmartPilot has a built in automatic tack facility (AutoTack) that turns the boat through 100° in the required direction:

- to AutoTack to port: press the **-1** and **-10** keys together
- to AutoTack to starboard: press the **+1** and **+10** keys together

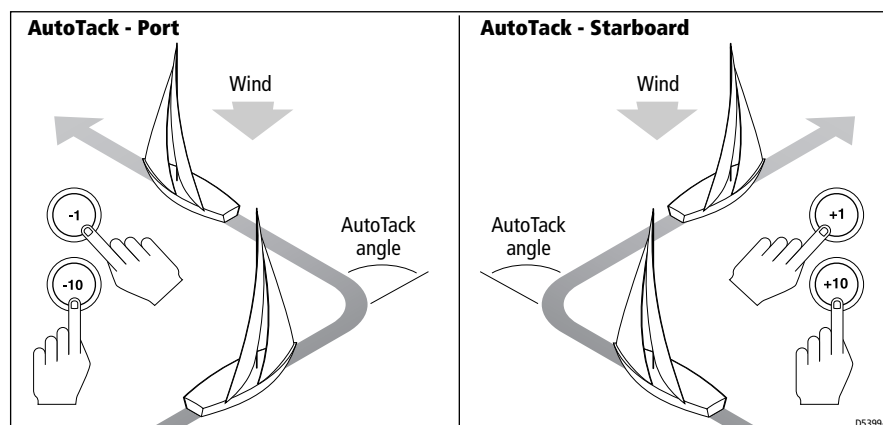

Note: If you have set the vessel type to SAIL BOAT, you can adjust the default AutoTack angle in User Calibration (see page 24).

When you AutoTack in Wind Vane mode, the boat turns through the AutoTack angle. The SmartPilot will then trim the heading to mirror the locked wind angle from the previous tack.

Operating hints for Wind Vane mode

- Always trim your sails carefully to minimize the amount of standing helm.
- Reef the headsail and mainsail a little early rather than too late.
- In Wind Vane mode the SmartPilot will react to long-term wind shifts, but will not correct for short-term changes such as gusts.
- In gusty and unsteady inshore conditions, it is best to sail a few degrees further off the wind so that changes in wind direction can be tolerated.

2.3 How do I display boat data?

Use the **disp** key to show 'data pages' of SeaTalk or NMEA data:

1. Press **disp** to access the first data page, and press it again to cycle through each data page in turn:
 - when you cycle past the last data page, the display returns to the current SmartPilot mode screen (for example, AUTO)
 - 4 data pages are set in the factory as a default (see diagram): within User setup you can select up to 15 pages and control the information they display (see page 23)

- Notes:** (1) *If the SmartPilot system cannot obtain the required information, the data page will show dashes instead of a value.*
- (2) *The direction-to-steer arrows relate to the data page information.*
- (3) *Most data pages show repeated data so you cannot adjust them: the exceptions are the RESPONSE and RUDDER GAIN data pages, which you can adjust using the **or up/down** arrow keys*

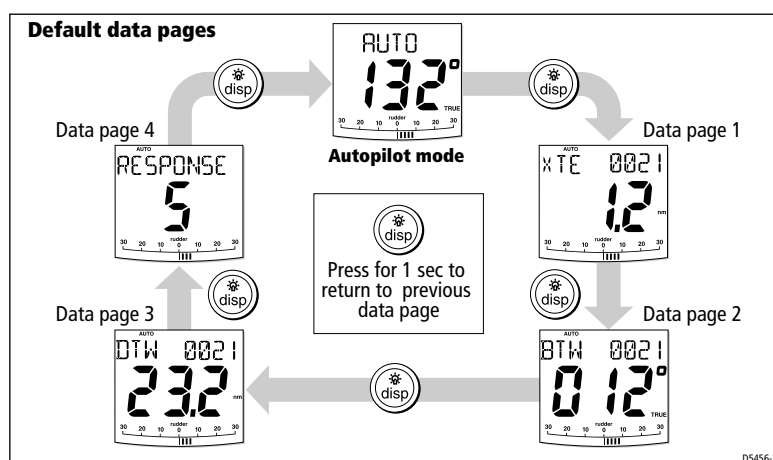

Can I display Waypoint names?

If the waypoints have been given names, the ST7001 will display them on the Cross Track Error (XTE), Bearing To Waypoint (BTW) and Distance To Waypoint (DTW) data pages:

- waypoint names of five characters or less are displayed together with the page name (as shown by screen A below)
- waypoint names of more than five characters alternate with the page name (as shown by screen B below)
- if the waypoint name has more than nine characters, the display only shows the first nine characters

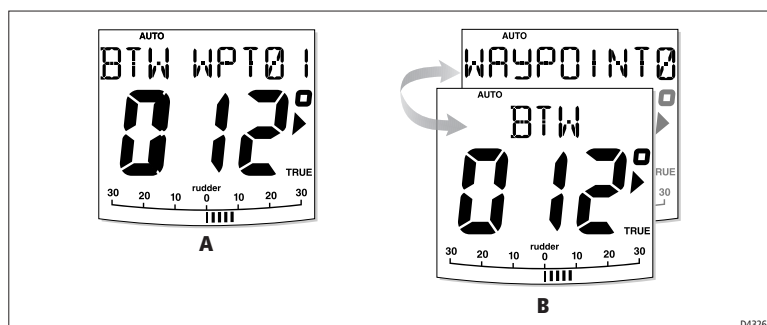

Warning messages

Shallow warning (SHALLOW)

The SmartPilot shows the Shallow warning if it receives a shallow depth message from an instrument on the SeaTalk system. Press **standby** or **disp** to cancel the warning.

Man Overboard warning (MOB)

The SmartPilot activates the Man Overboard warning if it receives a man overboard (MOB) message from another instrument on the SeaTalk system. It displays the text MOB instead of the waypoint number for the XTE, DTW and BTW data pages.

2.4 User Calibration Options

The calibration information in this handbook relates to only those settings that can be adjusted during normal operation (USER CAL). For information on all available calibration settings, see *SmartPilot Commissioning Guide*.

Note: *Many of the settings are sailboat specific and will only be displayed if your vessel type is set to SAILBOAT*

How do I access User Calibration settings?

You can only access the calibration mode from Standby mode:

1. With the SmartPilot in Standby mode, press and hold the **standby** key for 2 seconds. The display will change to show DISPLAY CAL.
2. Press the **disp** key once, the display will now show USER CAL.

3. Press **auto** to enter User Calibration.
The first page of User Calibration will now be displayed.
4. To access other User Calibration pages, press **disp** to scroll down through the items within that grouping:
5. When you reach an item you wish to adjust, use the **-1, +1, -10** and **+10** keys (as appropriate) to change the value.
6. When you have made all the changes you want to make, press and hold **standby** for two seconds to exit calibration mode and save changes.

User Calibration pages

AutoTack angle (SAILBOAT only)

The AutoTack angle is the angle through which the boat will turn when you select an automatic tack.

Screen Text	Options
AUTO TACK	40° to 125° in 1° steps

Gybe inhibit (SAILBOAT only)

With gybe inhibit on:

- you will be able to perform an AutoTack into the wind
- to prevent accidental gybes, the SmartPilot will prevent the boat from performing an AutoTack away from the wind

With gybe inhibit off, you can perform an AutoTack into or away from the wind.

Screen Text	Options
GYBE STOP	ON (Default) = Gybe inhibit on (gybes prevented) OFF = Gybe inhibit off (gybes permitted)

Wind selection (SAILBOAT only)

This screen determines whether the boat steers to apparent or true wind in Wind Vane mode.

Options	
WIND APP (Default)	SmartPilot steers to apparent wind angle
WIND TRUE	SmartPilot steers to true wind angle

WindTrim (SAILBOAT only)

WindTrim controls how quickly the SmartPilot responds to changes in the wind direction. Higher wind trim settings will result in a system that is more responsive to wind changes.

Screen Text	Options
WIND TRIM	Range = 1 to 9 1 to 3 - Least responsive to wind changes (less system activity) 4 to 6 - Moderate response to wind changes 7 to 9 - Most responsive to wind changes (more system activity)

Response level

This sets the default SmartPilot response level setting. The response level controls the relationship between course keeping accuracy and the amount of helm/drive activity. You can make temporary changes to response during normal operation (see Operation Guide).

S1G, S2G and S3G systems

Screen Text	Options
RESPONSE	Range = 1 to 9 levels 9 to 7 gives the tightest course keeping and greatest rudder activity (and power consumption). This can lead to a rough passage in open waters as the SmartPilot may 'fight' the sea. levels 6 to 4 should give good course keeping with crisp, well controlled turns under normal operating conditions levels 3 to 1 minimizes the amount of pilot activity. This conserves power, but may compromise short-term course-keeping accuracy

Non-G SmartPilot systems

Screen Text	Options
RESPONSE 1	AutoSeastate on (Automatic deadband) The SmartPilot will gradually ignore repetitive boat movements and only react to true variations in course. This provides the best compromise between power consumption and course keeping accuracy
RESPONSE 2	AutoSeastate off (minimum deadband) This setting provides tighter course keeping but will lead to increased power consumption and drive unit activity
RESPONSE 3	AutoSeastate off + counter rudder yaw damping This setting provides the tightest possible course keeping by introducing counter rudder yaw damping

Chapter 3: Fault Finding & Maintenance

All Raymarine products are designed to provide many years of trouble-free operation. We also put them through comprehensive testing and quality assurance procedures before shipping.

This chapter provides information about identifying problems, interpreting alarm messages, maintaining your SmartPilot and obtaining product support.

If a fault occurs with your SmartPilot, use the fault finding tables in this section to help identify the problem and provide a solution. If you cannot resolve the problem yourself, refer to the product support information.

3.1 Fault finding

SYMPTOM	POSSIBLE CAUSE and SOLUTION
Display is blank	No power – check the power and SeaTalk fuses on course computer, then check main fuse/circuit breaker.
Data page display shows stationary dashes	The control unit is not receiving necessary data from other instruments – check cabling.
Display shows rotating dashes	Compass calibration in progress (see SmartPilot Commissioning Guide).
Displayed compass heading does not agree with the boat's compass	You have not calibrated the compass. Carry out the deviation and alignment procedures (see SmartPilot Commissioning Guide).
No display bar on the display	Rudder bar switched off in Display Calibration – select RUDD BAR or STEER BAR
Rudder bar display moves in opposite direction to rudder	Reverse the red and green rudder position sensor connections at the course computer
Boat turns slowly and takes a long time to come onto course	Rudder gain too low. Complete AutoLearn or increase gain setting.
Boat overshoots when turning onto a new course	Rudder gain too high. Complete AutoLearn or decrease gain setting.
The SmartPilot 'hunts' when trying to position the rudder	Adjust the RUDD DAMP setting (see SmartPilot Commissioning Guide). Increase the damping one level at a time until the autopilot stops hunting, and always use the lowest acceptable value

SYMPTOM	POSSIBLE CAUSE and SOLUTION
The SmartPilot appears to be unstable on Northerly headings in the Northern hemisphere (or Southerly headings in the Southern hemisphere)	Northerly/Southerly heading correction (AutoAdapt) is not set up (see SmartPilot Commissioning Guide). [Does not apply to S1G, S2G and S3G systems.]
You cannot enter Seatrial Calibration	Seatrial calibration lock is on – turn off the calibration protection feature in Dealer Calibration (see SmartPilot Commissioning Guide).
The SmartPilot will not ‘talk’ to other SeaTalk instruments	Cabling problem – make sure all the cables are connected properly.
Position information not received	Navigator not transmitting the correct position data.
The SmartPilot will not auto advance to the next waypoint	No bearing to waypoint information received from the navigator.
Non-Raymarine 24V autopilots clutch slipping	Check that the clutch fuse is in the correct position. E.g. 24 V position for 24 V clutches.
When holding a constant course in STANDBY mode, the heading continuously changes	The Autopilot is connected to a Raymarine Pathfinder unit with the “Bridge NMEA Heading” option switched on. Disable this feature on the Pathfinder unit.

SmartPilot alarm messages

When the SmartPilot detects a fault or failure on the system, it will activate one of the alarm messages listed in the following table.

- Unless otherwise stated, you should respond to the alarm by pressing **standby** to clear the alarm and return to manual control, before you attempt to resolve the problem.
- In some situations, the SmartPilot will raise more than one alarm. When you have dealt with the first alarm, it will display the next alarm.

ALARM MESSAGE	POSSIBLE CAUSE and SOLUTION
AUTO RELEASE	Possible fault with rudder position sensor – check connections. OR Stern (I/O) drives only – you have taken manual control of steering with AutoRelease on. The alarm cancels automatically after 10 seconds.
CURRENT LIMIT	Serious drive failure – the drive is taking too much current due to short-circuit or jamming. Check the drive unit.

ALARM MESSAGE	POSSIBLE CAUSE and SOLUTION
DRIVE STOPPED	The autopilot is unable to turn the rudder (this occurs if the weather load on helm is too high, or if the rudder position sensor has passed beyond the preset rudder limits or rudder end-stops). Check drive and rudder position sensor.
LOW BATTERY	Supply voltage has dropped below acceptable limits. To respond to a Low Battery alarm: <ul style="list-style-type: none"> • press standby to clear the alarm and return to hand steering • start the engine to recharge the battery
LRN FAIL 1, 2 or 4	AutoLearn not completed successfully. Failure codes: 1 = AutoLearn has not been carried out (default setting) 2 = AutoLearn failed, usually due to manual interruption 4 = AutoLearn failed, probably due to drive or compass failure Repeat the AutoLearn procedure.
MOT POW SWAPPED	Motor cables are connected to power terminals (and power cables are connected to motor terminals) at course computer. Turn off power and swap over connections.
NO DATA	Caused by any of the following situations: <ul style="list-style-type: none"> • the compass is not connected • the autopilot is in Wind Vane mode and it has not received wind angle data for 30 seconds • the autopilot is in Track mode and: <ul style="list-style-type: none"> • the autopilot is not receiving SeaTalk navigation data, or • the position sensor (GPS, Loran, Decca) is receiving a low strength signal – this will clear when the signal improves Check connections to the compass, wind instrument and navigator. Note: The autopilot stops adjusting the heading as soon as it loses data.
NO PILOT	The controller is not receiving data from the SmartPilot computer. Check connections and check course computer is switched on.
RG FAIL	GyroPlus yaw sensor has failed: <ul style="list-style-type: none"> • If you have a S1G, S2G or S3G course computer with internal GyroPlus sensor – call a Raymarine service agent. • If you have a Non-G³ course computer with external GyroPlus yaw sensor – check the sensor and connections, then call a Raymarine service agent.
SEATALK and FAIL 1 or 2	SeaTalk data problem on one of the SeaTalk lines – check connections.
SEATALK and FAIL	The control unit cannot transmit data to the SeaTalk system. Make sure all SeaTalk cables are connected properly.

3.2 General maintenance

Routine checks

CAUTION:

The SmartPilot computer and controller do not contain any user serviceable parts. It should be serviced only by authorized Raymarine service technician.

The SmartPilot computer does NOT contain user-serviceable parts. If you remove the main cover you will invalidate the warranty. The controller is also a sealed unit. As a result, user maintenance is limited to the following checks

- make sure all cable connectors are firmly attached
- examine for signs of wear or damage – replace any damaged cables

Note: Do *not* use chemical or abrasive materials to clean the SmartPilot computer. If the case is dirty, wipe it with a clean, damp cloth.

Cleaning the display

CAUTION:

Take care when cleaning the display. Avoid wiping the display screen with a dry cloth as this could scratch the screen coating. If necessary, only use a mild detergent.

- Never use chemical or abrasive materials to clean the controller. If it is dirty, wipe it with a clean, damp cloth.
- In certain conditions, condensation may appear inside the display screen. This will not harm the unit, and you can clear it by switching on the illumination for a short time.

EMC advice

- When powered up, all electrical equipment produces electromagnetic fields. These can cause adjacent pieces of electrical equipment to interact with one another, with a consequent adverse effect on operation.
- To minimize these effects and enable you to get the best possible performance from your Raymarine equipment, guidelines are given in the installation instructions, to enable you to ensure minimum interaction between different items of equipment, i.e. ensure optimum Electromagnetic Compatibility (EMC).
- Always report any EMC-related problems to your nearest Raymarine dealer. We use such information to improve our quality standards.

- In some installations, it may not be possible to prevent the equipment from being affected by external influences. In general this will not damage the equipment but it can lead to spurious resetting action, or momentarily may result in faulty operation.

Product support

Raymarine products are supported by a worldwide network of distributors and Authorized Service Representatives. If you encounter any difficulties with this product, please contact either your national distributor, service representative, or the Raymarine Technical Services Call Center. Refer to the back cover or the Worldwide Distributor List for contact details.

Before you consider returning the autopilot, make sure that the power supply cable is sound and that all connections are tight and free from corrosion. If the connections are secure, refer to the Fault Finding section in this chapter.

If you cannot trace or rectify the fault, contact your nearest Raymarine dealer or Service Center, specifying:

- the SmartPilot controller and SmartPilot computer serial numbers:
 - the controller serial number is printed on its rear cover
 - the computer serial number is printed under its connector cover
- the controller and computer software version numbers

The following illustration shows how to display the software information:

- press and hold **standby** for 4 seconds:
 - after 2 seconds you will see the DISPLAY CAL screen
 - then after another 2 seconds you see controller software version
- press **disp** to display the computer software version
- press **disp** again to display the total number of hours the SmartPilot has been used in Auto mode.

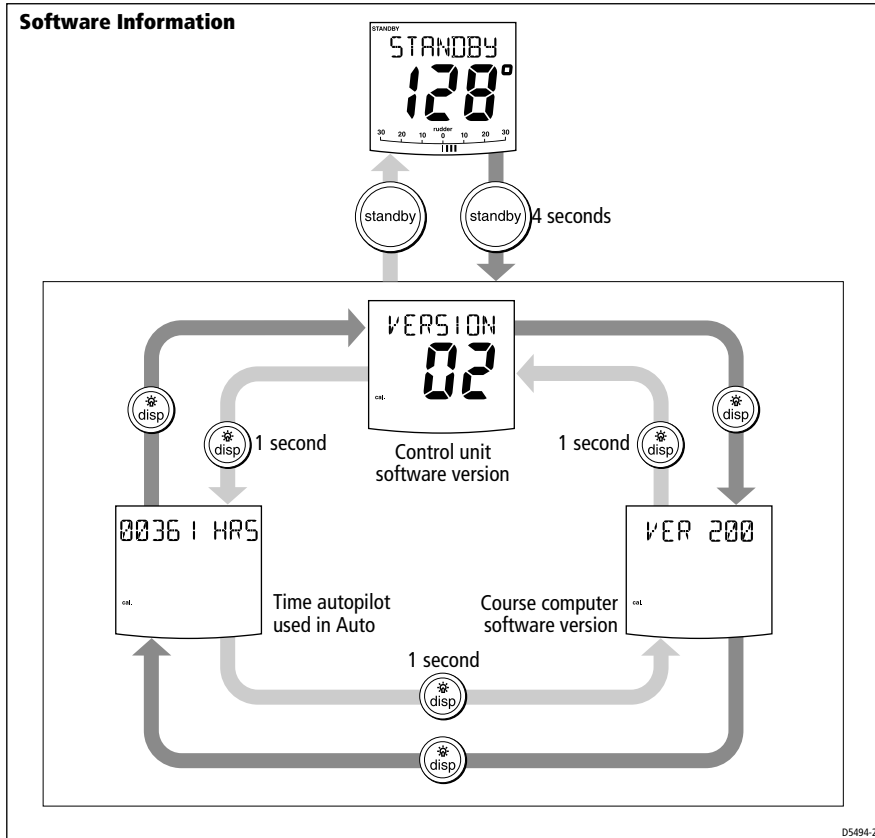

Product details table

For future reference, you may want to use this table to record serial and software information for your SmartPilot:

Serial Number	Software Version
SmartPilot Controller	
SmartPilot Computer	
Hours Used	hours

Specifications

ST7001 control unit

Nominal supply voltage:	12 V DC via SeaTalk
Operating voltage range:	10 V to 15 V DC
Current consumption (in Standby mode)	50 mA (less than 120 mA with full lighting)
Operating temperature:	0 °C to +70 °C (32 °F to 158 °F)
Water protection:	waterproof to CFR46
Overall dimensions:	
width	175 mm (6.9 in)
height	115 mm (4.53 in)
depth	41 mm (1.62 in)
Keypad:	13 button illuminated keypad
Liquid Crystal Display (LCD):	shows heading, locked course and navigational data, and up to 15 data pages
LCD illumination:	3 brightness levels + off; 15 contrast levels
Input connections:	SeaTalk (x2) and NMEA 0183
Output connections:	SeaTalk (x2)
CE approvals:	conforms to: 89/336/EC (EMC), EN60945:1997

SmartPilot computer functions

Controller	SmartPilot computer	
	S1G, S2G and S3G systems	Non-G systems
ST7001	<ul style="list-style-type: none"> • Internal GyroPlus yaw sensor • Enhanced course keeping using AST • FastTrim • Full access to AutoLearn, providing automatic steering calibration • Improved track-keeping • Steers to true and apparent wind in Wind Vane mode • Improved calibration access 	<ul style="list-style-type: none"> • Full basic functionality • Improved track-keeping • Steers to true and apparent wind in Wind Vane mode • Improved calibration access, but without AutoLearn • Uses Raymarine steering algorithm without AST • No FastTrim

Glossary

Term	Meaning
AST	Advanced Steering Technology (AST) is Raymarine's unique advanced steering algorithm. It uses inputs from a wide variety of sensors to tune the autopilot's operation to provide superior control of the boat in any condition.
AutoLearn	Self-learning calibration feature available on S1G, S2G and S3G autopilot systems.
AutoTrim	The AutoTrim setting determines the rate at which the autopilot applies 'standing helm' to correct for trim changes caused by varying wind loads on the sails or superstructure.
AWG	American Wire Gauge
CE	Marked on Raymarine products that comply with defined European Community standards
counter rudder	Counter rudder is the amount of rudder the autopilot applies to try to prevent the boat from yawing off course. Higher counter rudder settings result in more rudder being applied.
CR pump	Constant Running hydraulic pump
DC	Direct current
EMC (Electromagnetic Compatibility)	When powered up, all electrical equipment produces electromagnetic fields. These can cause adjacent pieces of electrical equipment to interact with one another, and this can degrade their performance. By following the EMC guidelines in this handbook, you can minimize these effects by ensuring optimum Electromagnetic Compatibility (EMC) between equipment.
Fluxgate	Standard Raymarine compass supplied with course computer core pack
GPS	Global Positioning System
GyroPlus	Raymarine's GyroPlus yaw sensor that measures the boat's rate of turn. It is built into the S1G, S2G and S3G course computers.
I/O drive	Inboard/Outboard or stern drive
MOB	Man overboard
nm	Nautical mile
NMEA	The NMEA (National Maritime Electronics Association) protocol is an internationally accepted serial communication interface standard for sharing data between electronic equipment. Raymarine products can share information with non-SeaTalk equipment using the NMEA 0183 protocol.

Term	Meaning
response	The autopilot response level controls the relationship between course keeping accuracy and the amount of helm/drive activity.
rudder gain	Rudder gain is a measure of how much helm the autopilot will apply to correct course errors. The higher the setting the more rudder will be applied.
SeaTalk	SeaTalk is Raymarine's proprietary communication system. It links the products to provide a single, integrated system sharing power and data.
SeaTalk bus	This refers to the continuous SeaTalk system connecting together a series of Raymarine units.
SM	Statute (land) mile
VHF	Very High Frequency (radio)
WindTrim	WindTrim (wind response) controls how quickly the autopilot responds to changes in the wind direction. Higher wind trim settings will result in a pilot that is more responsive to wind changes.
XTE	Cross track error
Yaw	The boat's rate of turn (°/sec)

Index

A

- Alarms 28
 - AUTO RELEASE 28
 - CURRENT LIMIT 28
 - DRIVE STOPPED 29
 - LARGE XTE 14
 - LOW BATT 29
 - LRN FAIL 29
 - MOB 23
 - MOT POW SWAPPED 29
 - NEXT WPT 17
 - NO DATA 29
 - NO PILOT 29
 - OFF COURSE 9
 - RG FAIL 29
 - SEATALK FAIL 1 or 2 29
 - SEATALK/STLK FAIL 29
 - SHALLOW 23
 - WINDSHIFT 20
- Auto mode 5
 - AutoTack 9
 - Changing course 6
 - Dodging obstacles 6
 - Off course warning 9
- AutoRelease
 - Alarm 28
- AutoTack 9, 24
 - in wind vane mode 20

C

- Contrast 12
- Controller
 - Specifications 33
- Course changes 6
- Cross track error
 - Explanation 14
 - LARGE XTE warning 14
- Current limit alarm 28

D

- Data pages 21
- Display

Contrast 12

- Dodging obstacles
 - Auto mode 6
- Drive stopped alarm 29

F

- Fault finding 27
- Following a route 13

G

- Glossary 34-35
- Gybe inhibit 9, 25
- GyroPlus fail alarm 29

K

- Keypad functions 3

L

- Learn fail alarm 29
- Low battery alarm 29

M

- Maintenance 30
- Man Overboard alarm 23
- Motor/Power swapped alarm 29

N

- Next WPT warning 17
- No data alarm 29
- No pilot alarm 29

O

- Off course warning
 - Description 9

P

- Performance 7
- Preventing gybes 9
- Product support 31

R

- Response level 26
- RG fail alarm 29
- Route completed 17

S

- Safety notices iii
 - Track mode 18
- Sailboats
 - AutoTack 9
 - Preventing gybes 9
- SeaTalk
 - SeaTalk fail 1 or 2 29
 - SeaTalk fail alarm 29
- Service 31
- Settings
 - AutoTack 24
 - Gybe inhibit 25
 - Response level 26
 - User calibration 23
 - Wind type 25
- Shallow alarm 23
- SmartPilot
 - Disengaging 5
 - Engaging 5
 - Functions 2, 33
- Specifications 33
- Standby Mode 5

T

- Technical support 31
- Track mode 13
 - Cross track error 14
 - Next waypoint 17
 - Route completed 17
 - Safety 18
 - Tidal compensation 15
 - Waypoint names 22

U

- User Calibration 23

W

- Waypoint
 - Advance 16
 - Arrival 16
 - Skipping 16
- Wind angle
 - Adjusting 19
- Wind type 25

- Wind vane mode 18
 - Adjusting wind angle 19
 - Apparent wind 18
 - AutoTack 20
 - Enabling 19
 - Operating hints 21
 - True wind 18
 - Wind shift warning 20
 - WindTrim 18
- WindTrim 18

Warranty Certificate

The Raymarine warranty terms and conditions as described below do not affect the customer's statutory rights.

Limited Warranty

Raymarine warrants each new Light Marine Product to be of good materials and workmanship. Raymarine, or its approved agents, will repair or exchange under warranty any parts proven to be defective in material or workmanship under normal use, for a period of 2 years/24 months from date of sale to end user, or 30 months from date of shipment from Raymarine – whichever expires first, except as provided below.

Raymarine Limited Warranty covers the parts and labor associated with any warranty repair as described above, provided that the unit is returned to Raymarine or one of its appointed agents.

Installed Warranty

In addition to the **Limited Warranty** cover as described above, Raymarine will, except as provided below, cover travel costs (auto mileage and tolls) up to 100 round trip highway miles (160 kilometers) and travel time of 2 hours, to enable onboard warranty service to be carried out on products where proof of installation or commission by Raymarine certified installers, can be shown.

The **Installed Warranty** provides for onboard repair or exchange, by Raymarine or its approved service agents, for a period of 2 years/24 months, from date of sale of the boat to the end user – where the equipment has been installed by a Raymarine certified installer, or from commissioning of the installation by a Raymarine certified installer, or 30 months from date of shipment of the equipment from Raymarine – whichever expires first, except as provided below.

Obtaining Warranty Service

In the event of Warranty service being required, contact Raymarine or the nearest Raymarine certified service agent – a full list of local service agents are available on the Internet or can be requested from the nearest Raymarine agent.

A suitable proof of purchase, showing date, place of purchase, and serial number must be made available to Raymarine or authorized service agent at the time of request for Warranty service.

In cases where a Raymarine certified installer has not installed the product; i.e. **Limited Warranty**, the affected unit must be returned to the local Raymarine approved service agent, with a copy of proof of purchase and/or completed warranty card. Subject to the Limitations below, the unit will be repaired/replaced at no further cost to the user and promptly returned to the user.

In cases where the equipment has been installed by a Raymarine certified installer (boat builder, installer dealer etc.), i.e. **Installed Warranty**, the nearest local service agent should be contacted and onboard service requested, the warranty card, correctly completed and stamped by the installing agent, must be available as authorization for onboard service.

Continued . . .

Warranty Limitations

Raymarine Warranty policy does not apply to equipment that has been subjected to accident, abuse or misuse, shipping damage, alterations, corrosion, incorrect and/or non-authorized service, or equipment on which the serial number has been altered, mutilated or removed. Raymarine assumes no responsibility for damage incurred during installation or as a result of improper installation.

This Warranty does not cover routine system checkouts, alignment/calibration, sea-trials or commissioning, unless required by replacement of part(s) in the area being aligned.

A suitable proof of purchase, showing date, place, and serial number must be made available to Raymarine or authorized service agent at the time of request for Warranty service.

Consumable items, (such as: fuses, batteries, drive belts, radar mixer diodes, snap-in impeller carriers, impellers, impeller bearings, and impeller shaft) are specifically excluded from this Warranty.

All costs associated with transducer replacement, other than the cost of the transducer itself, are specifically excluded from this Warranty.

Overtime/premium labor portion of services outside of normal working hours is not covered by this Warranty.

Travel cost allowance on certain products with a suggested retail price below \$2500.00 is not authorized. When/or if repairs are necessary, these products must be forwarded to a Raymarine facility or an authorized dealer at owner's expense and then will be returned via surface carrier at no cost to the owner.

Travel costs other than auto mileage, tolls and two (2) hours travel time, are specifically excluded on all products. Travel costs, which are excluded from the coverage of this Warranty, include but are not limited to: taxi, launch fees, aircraft rental, subsistence, customs, shipping and communication charges etc. Travel costs, mileage and time, in excess to that allowed must have prior approval in writing.

TO THE EXTENT CONSISTENT WITH STATE AND FEDERAL LAW:

(1) THIS WARRANTY IS STRICTLY LIMITED TO THE TERMS INDICATED HEREIN, AND NO OTHER WARRANTIES OR REMEDIES SHALL BE BINDING ON RAYMARINE INCLUDING WITHOUT LIMITATION ANY WARRANTIES OF MERCHANTABILITY OR FITNESS FOR A PARTICULAR PURPOSE.

(2) Raymarine shall not be liable for any incidental, consequential or special (including punitive or multiple) damages.

All Raymarine products sold or provided hereunder are merely aids to navigation. It is the responsibility of the user to exercise discretion and proper navigational skill independent of any Raymarine equipment.

Raymarine

Factory Service Centers

United States of America

Raymarine Inc
22 Cotton Road, Unit D
Nashua, NH 03063-4219, USA

Telephone: +1 603 881 5200
Fax: +1 603 864 4756
www.raymarine.com

Sales & Order Services

Telephone: +1 800 539 5539 Ext. 2333 or
+1 603 881 5200 Ext. 2333

Technical Support

Telephone: +1 800 539 5539 Ext. 2444 or
+1 603 881 5200 Ext. 2444
www.raymarine.com

Product Repair Center

Telephone: +1 800 539 5539 Ext. 2118

UK, Europe, Middle East, Far East

Raymarine Ltd
Anchorage Park, Portsmouth
PO3 5TD, England

Telephone: +44 (0)23 9269 3611
Fax: +44 (0)23 9269 4642
www.raymarine.com

Customer Support

Telephone: +44 (0)23 9271 4713
Fax: +44 (0)23 9266 1228

www.raymarine.com

Stick barcode label here

Purchased from

Purchase date

Dealer address

Installed by

Installation date

Commissioned by

Commissioning date

Owner's name

Mailing address

This portion should be completed and retained by the owner.

